

Execution of Customized Single Projects.

Interior and exterior signage of facades
Restoration of historical elements
High-end FF&E
Exclusive handles
Four Seasons Hotel and Private Residences



FOUR SEASONS



Fabrica y Oficinas
Calle Olof Palmé,11
4600 L´Alcudia
Valencia España

+34 960 263 035

+34 696 947 748

mariajose@mjmorell.com

www.mjmorell.com



M J M O R E L L

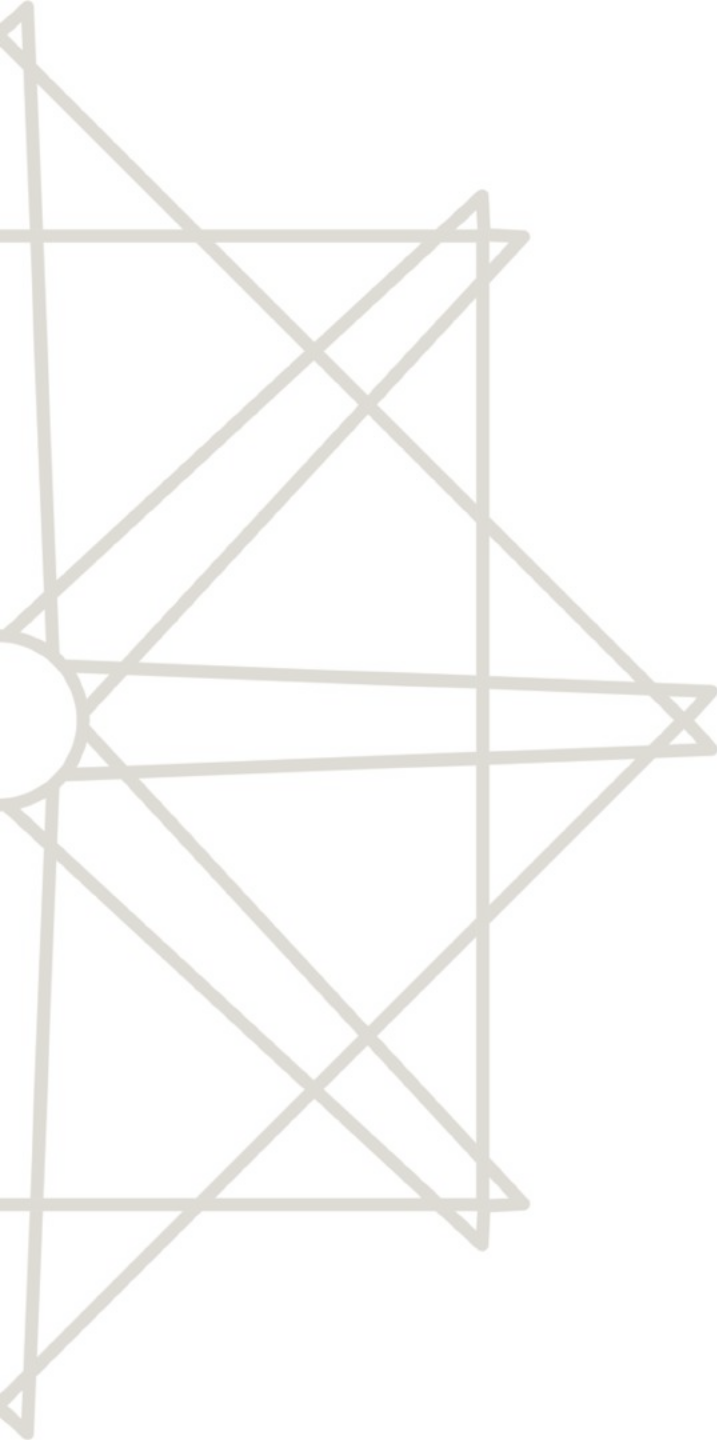

EXCELLENCY COSTUMIZED

At MJMorell we create unique customized projects with high quality parts and solutions. Unique pieces that reflect the **personality, exclusivity and luxury of our customers**, not only have excellent materials but are also made of the scarcest material in the world, Time.

From the **fittings to the furniture that we execute through lighting, restoration of historical elements of signage heritage and FF&E.**

We present some of the actions we have carried out at the **Madrid Canalejas Center...**

Four Seasons Hotel, Private Residences and currently at La Galería Comercial.

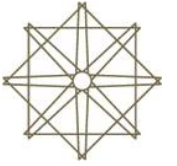

Facade Four Seasons Hotel Madrid

Main identification on the chamfer of Alcalá and Sevilla streets.



Restoration of heritage protected elements

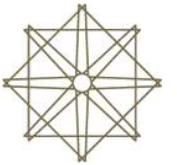

Historic elements restored and transformed into Identification of tradition and avant-garde

Entrance Four Seasons Private Residences Madrid

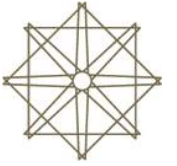

Execution of the 210 identification plates of the rooms combining artisan excellence with the latest technologies on noble materials, brass and oak. Inspired by the grills of the last building acquired for the creation of the urban complex Madrid Canalejas Center.

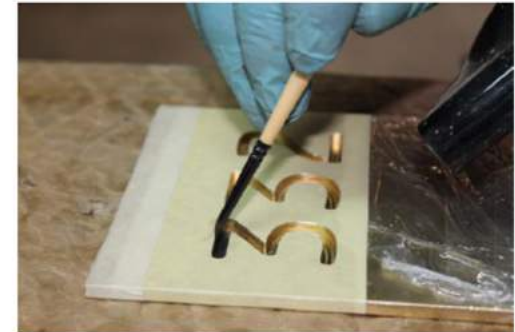

Rooms Four Seasons Hotel Madrid



M J M O R E L L

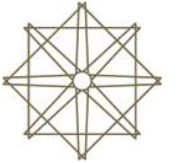

^ 200/227
< 206-226
Sala Neptuno >
^ Guardarropa
Cloakroom
^ Aseos
Restrooms

- o Identification of floors and common areas.
- o Directions.
- o Pictogram systems.
- o Identification of areas of attention.
- o Bellboy reception desk.

Common areas Four Seasons Hotel Madrid

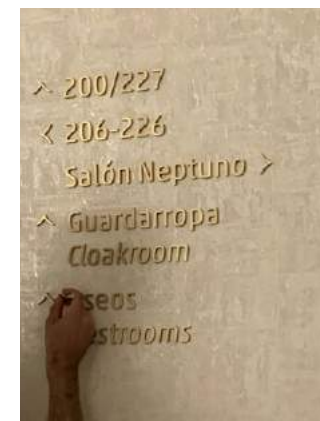
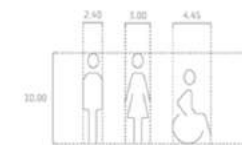

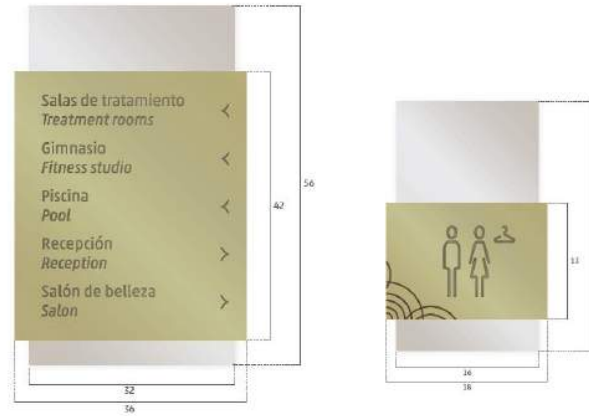

Brass and glass identification that combines the elegance and innovation of a **SPA and wellness**.

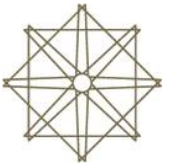

Identification SPA Four Seasons Hotel Madrid

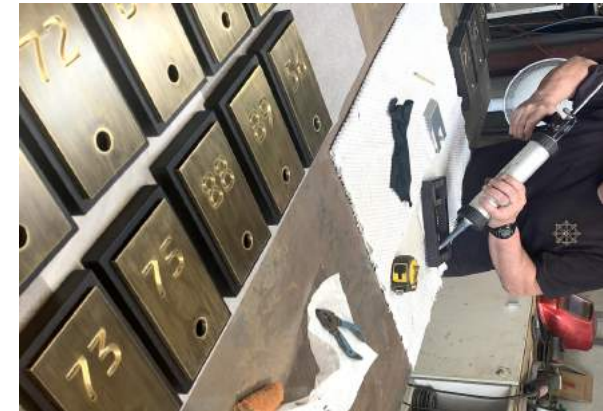
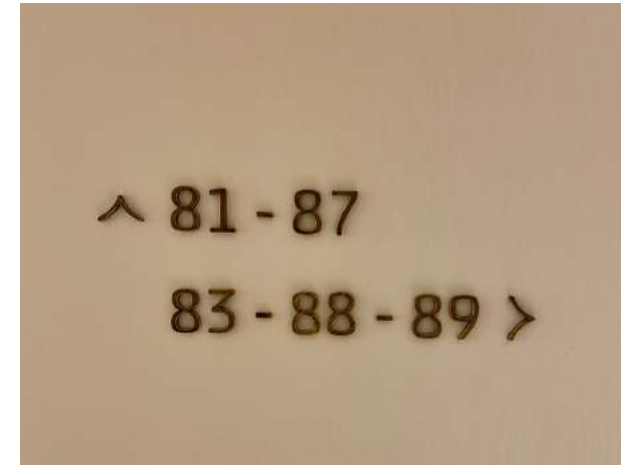
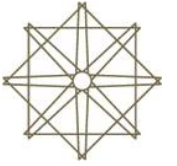

- **Private residence entrance** identification.
- Directions.
- Parking entrance to residences.

Four Seasons Private Residences Madrid



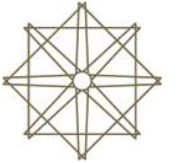

- Identification of restaurant areas.
- Back of the house.
- Canalejas Center Access.

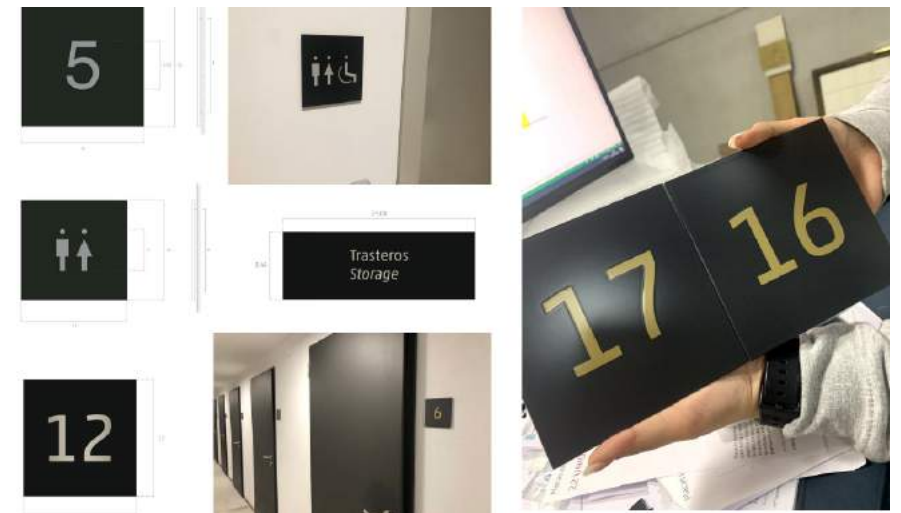

Restaurants of Four Seasons Hotel Madrid

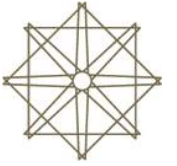

EXCELLENCY COSTUMIZED

MJMorell company wrapped in **luxury and exclusivity** since its inception has **prioritized quality** before quantity, not only of its materials and manufacturing but also of the **market to which they are directed**.

Different professional figures present in the Team allow the development and solution of every type of need from hotels or shopping centers, residential projects to all kinds of furniture and accessories.

Guest staircase of Four Seasons Hotel



M J M O R E L L

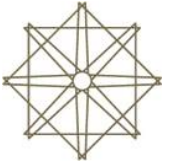
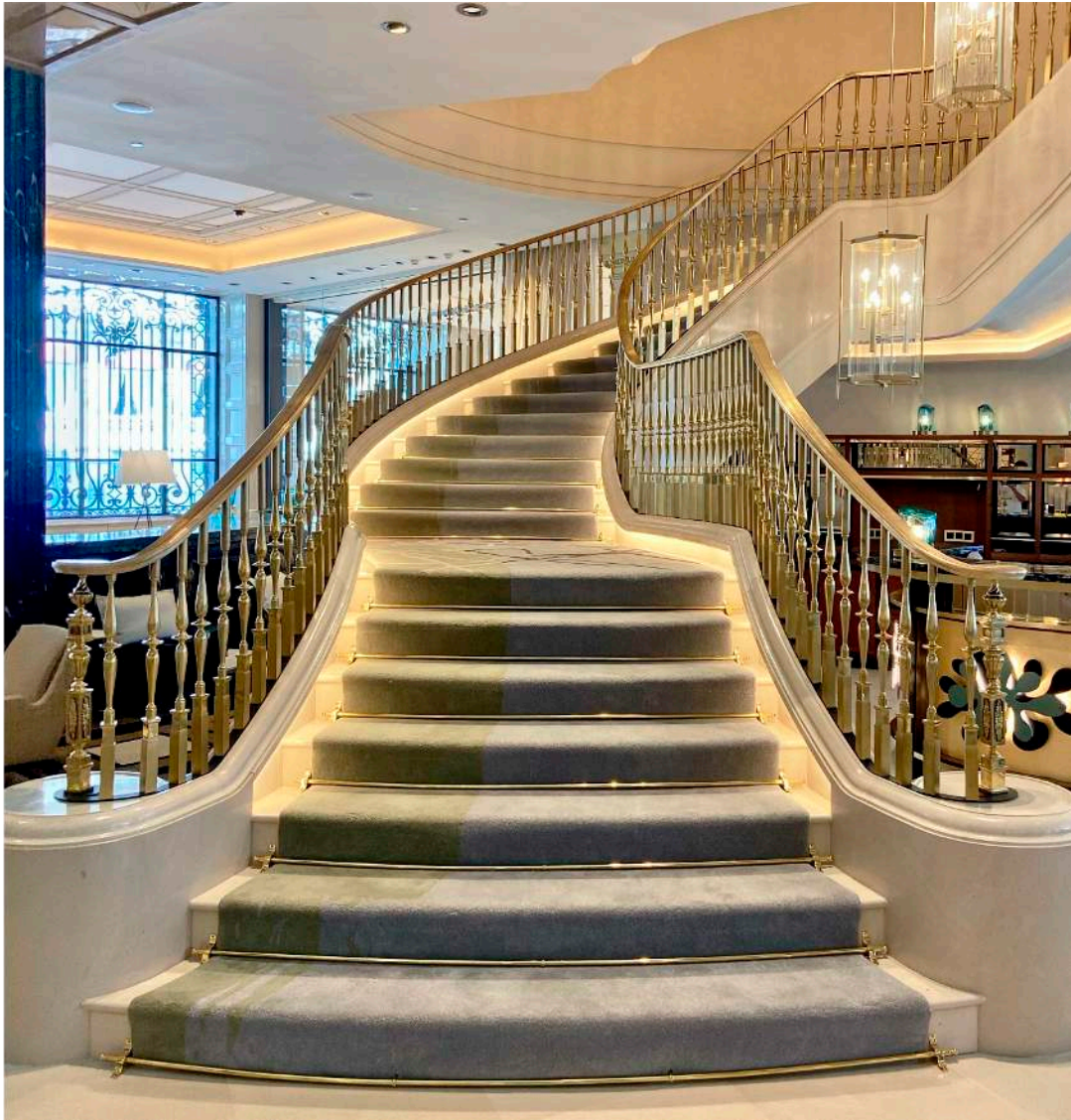

Staircase from the 20's belonging to the old Spanish Credit Bank. **Restoration** of 1070 brass balusters in our workshop to create **the Imperial Staircase** that today is part of **the Lobby and the interior guest stairs and all the hotel railings along with the starting pillars.**

Lobby Four Seasons Hotel Madrid



M J M O R E L L

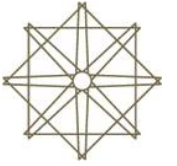

We manufacture in our workshop.

- Welding
- Retouching
- Brushing
- Polishing
- Patinating
- **Restorations**



M J M O R E L L

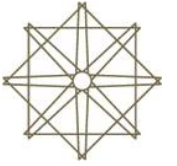

EXCELLENCY COSTUMIZED

Unique LIGHTING environments

At **MJMorell** we create unique environments with unique pieces and high-quality solutions combining innovative techniques with the excellency of artisan work and the careful choice of materials.

Know-how, commitment, passion...

Characterizes us and we apply in each project making it unique



Four Seasons Hotel Madrid



M J M O R E L L

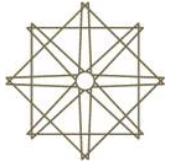
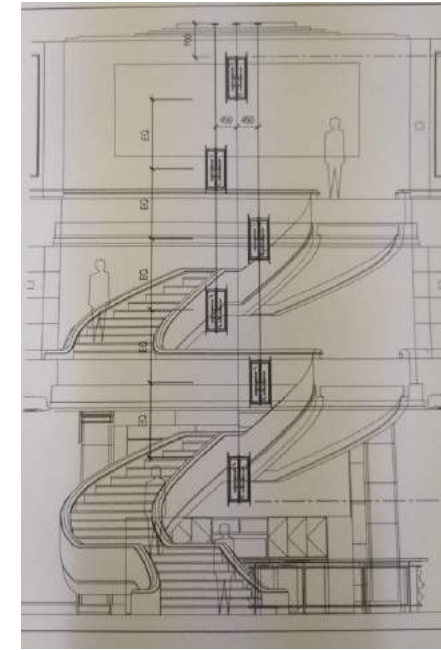
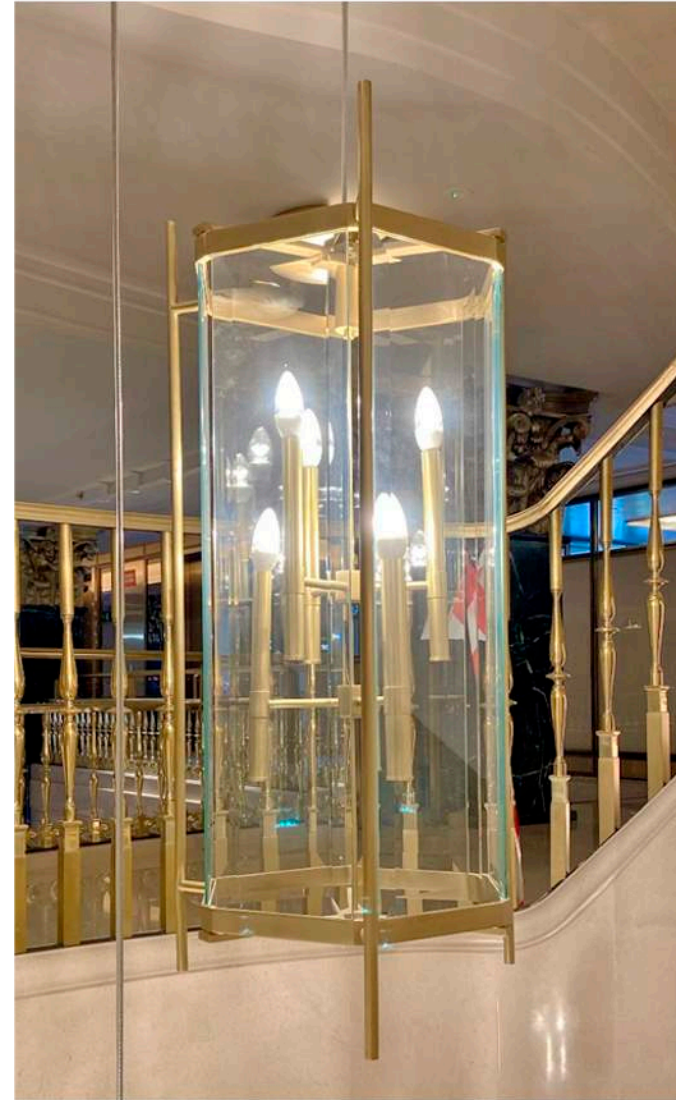

From a clients plan or idea
to our technical department...

- Unique pendant piece with 6 lightsources.
- Materials brass and glass.
- Measurements 1090 x 500 mm.

Lobby staircase Four Seasons Hotel Madrid



M J M O R E L L



- Unique pendant pieces with 3 light sources.
- Materials brass and glass.
- Measurements 1090 x 500 mm.

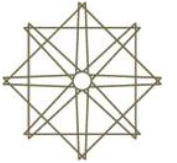

Creation of exclusive pieces, taking care of every detail, chain made link by link, lamp holder rosettes...

Lobby staircase basement -1 Four Seasons Madrid



M J M O R E L L



Our workshop

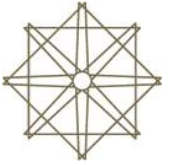

Lobby Four Seasons Hotel Madrid



M J M O R E L L

- Pendant pieces.
- Materials brass and glass.
- Measurements 1090 x 500 mm



- Pendant piece.
- Measurements 916 x 450 mm
- Materials brass and glass.
- Satin finish.

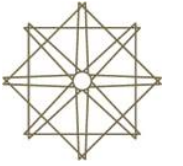

Common areas Four Seasons Hotel Madrid



M J M O R E L L

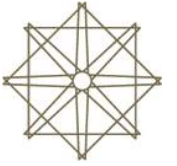

- Aplique piece 2 lamps.
- Measurements 1160 x 400 mm
- Material brass.
- Satin and polished finish.

Common areas Four Seasons Hotel Madrid



M J M O R E L L

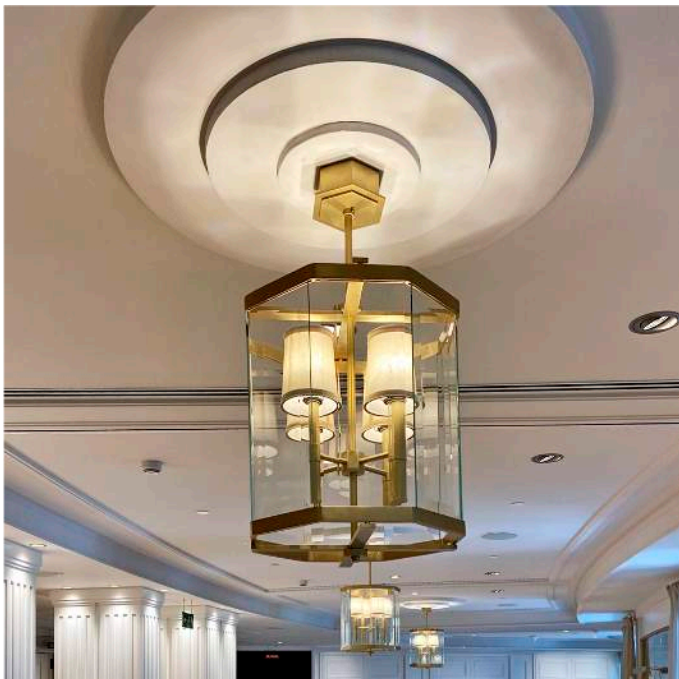

- Hexagonal pendant piece
- Measurements 800 x 450 mm
- Materials brass and glass
- Satin finish



- Square pendant pieces
- Measurements 885 x 360 mm
- Materials brass and acrylic glass
- Satin finish

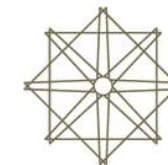

Royal Suite



- Alabaster plafond piece
- Measurements 254 x 500 mm
- Materials brass and alabaster
- Satin finish



- Aplique piece 2 arms
- Measurements 480 x 270 mm
- Material brass
- Satin and chrome finish

Common areas Four Seasons Hotel Madrid



Common areas Four Seasons Hotel Madrid



M J M O R E L L

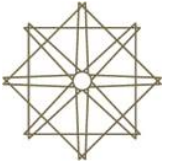

- Aplique piece
- Measurements 512 x 113 mm
- Materials brass and glass
- Satin finish

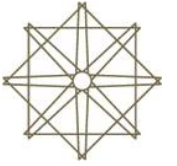

Restaurant Dani Four Seasons Hotel Madrid



M J M O R E L L

- Table lamp pieces
- Measurements 480 x 380 mm
- Materials bronze and glass
- Satin finish

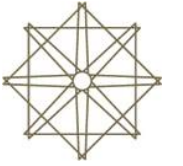

EXCELLENCY COSTUMIZED

GINKGO

Art applied to interior design and architecture

Is told by prestigious sculptors for realization of our designs, organic forms passed to bronze. We do not make furniture, we make works of art with the added value that no piece is the same as the others... All reflect the personality, exclusivity and luxury of our clients.





Lobby and Mezzanine Four Seasons Hotel Madrid



M J M O R E L L

- Unique Apliques Ginkgo pieces
- Material bronze
- Measurements 1470 x 400 mm
- Natural patinas finish

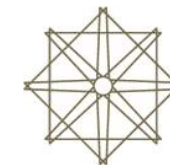

Manufacturing process

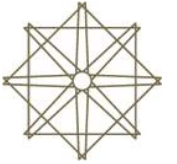

Ginkgo leaves modeled by our sculptors, cast in lost wax and in bronze, brushed and polished for the subsequent application of organic patinas.



In workshop

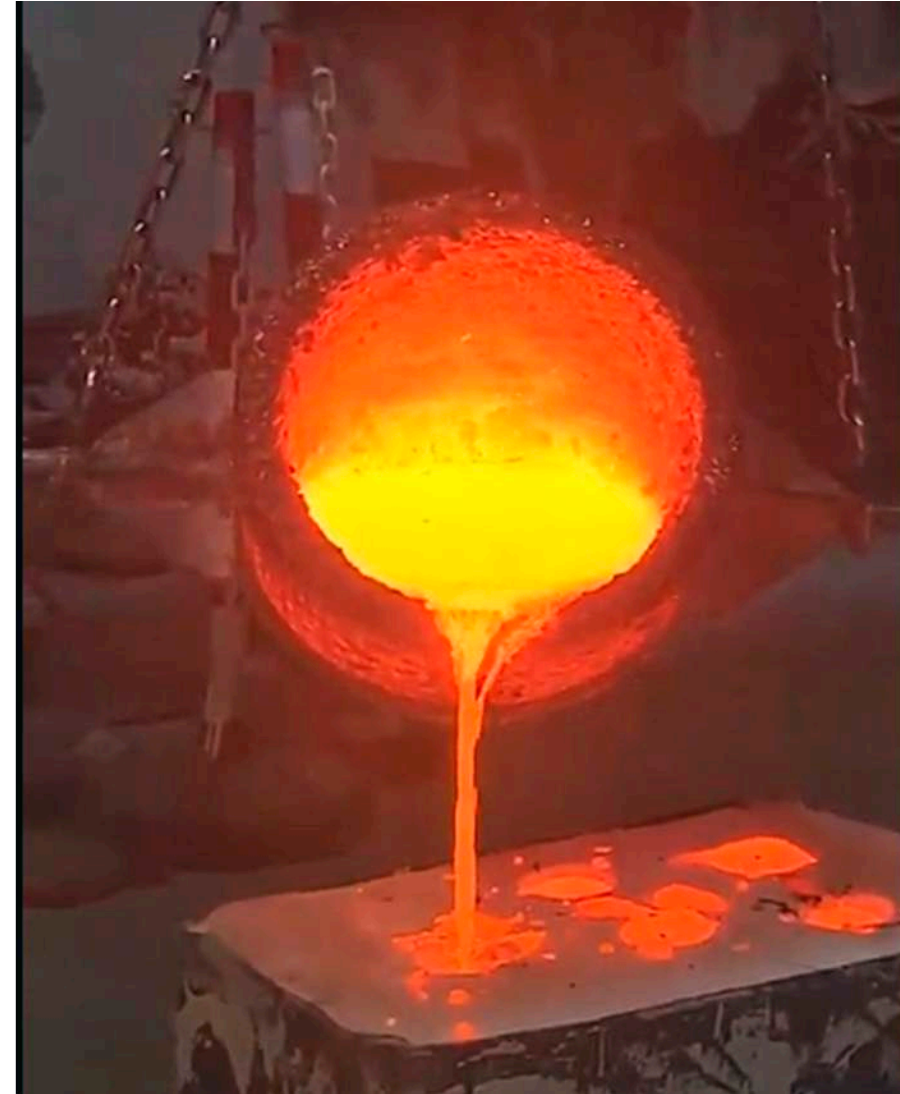



Welding the leaves to a structure previously manufactured.



Brushing and polishing the leaves.

Our workshop

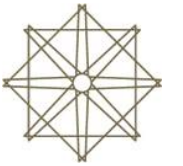

Organic patinas
made with fire.



LEAF INSPIRATION



M J M O R E L L

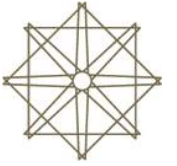

EXCELLENCY COSTUMIZED

FF&E

Showcases, custom furniture, unique pieces...

At **MJMorell** we aspire to the highest quality standards for this we have a **Multidisciplinary Team** of craftsmen specialized in noble materials, metalworkers, cabinetmakers, glassmakers, upholsterers... expert hands in their fields, **artisanal handwork** and **we combine it with the latest technologies** paying special attention to detail creating unique projects.



Lobby Four Seasons Hotel Madrid



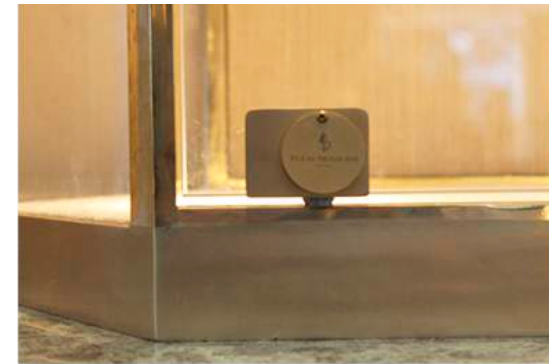
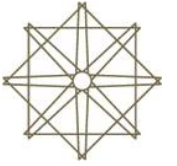

- VITRINA piece same base.
- Measurements 2000 x 1055 mm
- Material brass.
- Satin and polished finish.

Lobby Four Seasons Hotel Madrid



M J M O R E L L

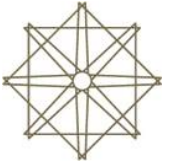

In our workshop we create all the manufacturing processes with highly qualified workers. Welding, revising, brushing...

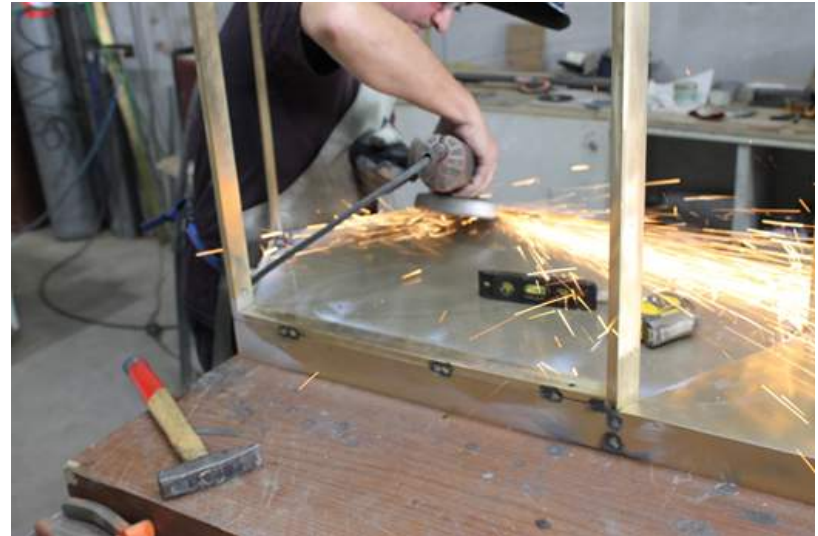

M J M O R E L L



Lobby Four Seasons Hotel Madrid

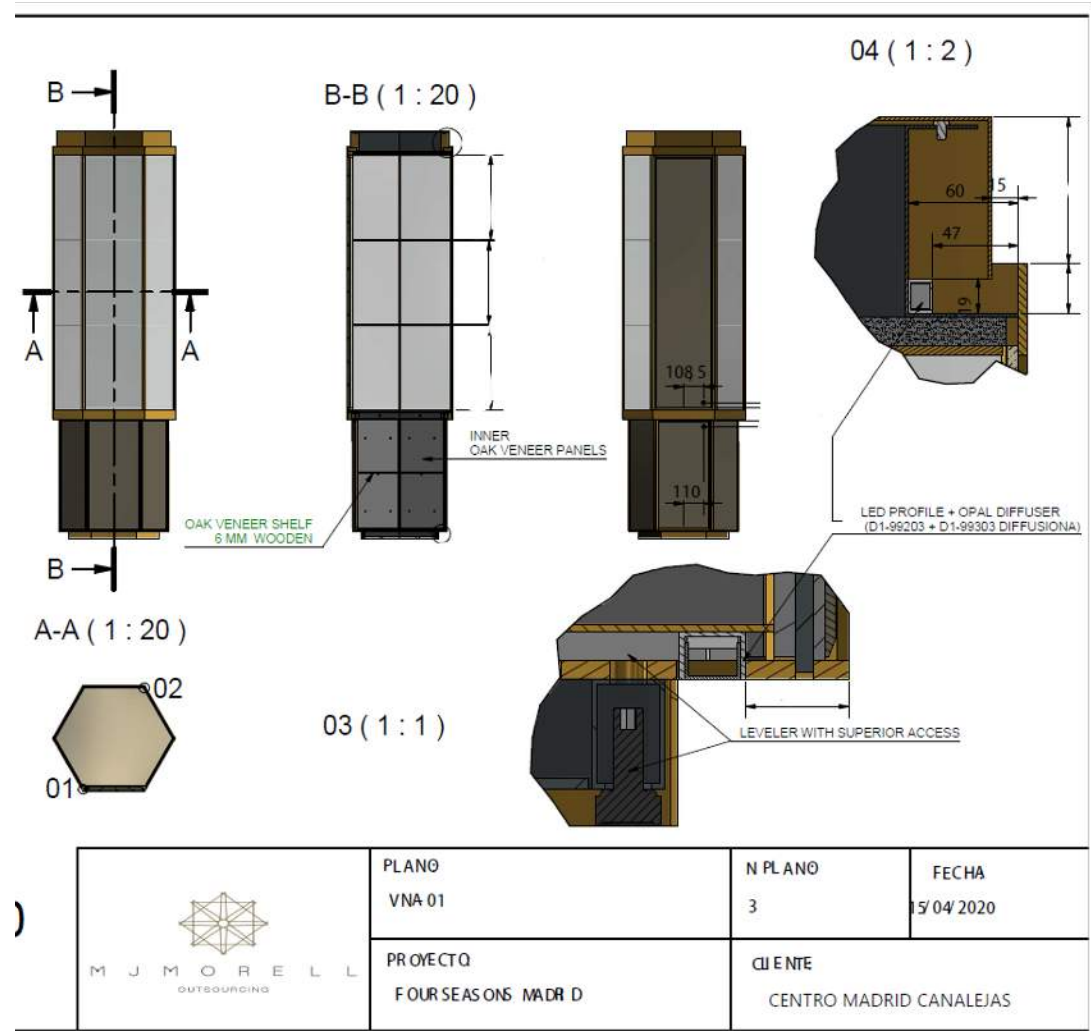

Technical Office Department.

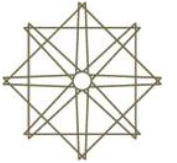

- Brass showcase piece with rear doors.
- Materials brass, interior oak.
- Measurements 2206 x 670 mm
- Satin and polished finish.

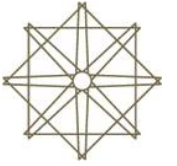

Our upholsterers with their expert hands upholstering the backs of the showcases.



In our workshop creating the internal structure

Internal structure.
Welding retouching.

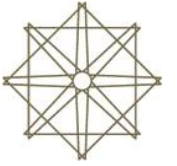



- **Unique VITRINA piede 6 doors**
- Materials brass, interior oak
- Measurements 2206 x 1800 mm
- Satin and polished finish



- **Unique VITRINA piece 4 doors**
- Materials brass, interior oak
- Measurements 2206 x 1600 mm
- Satin and polished finish

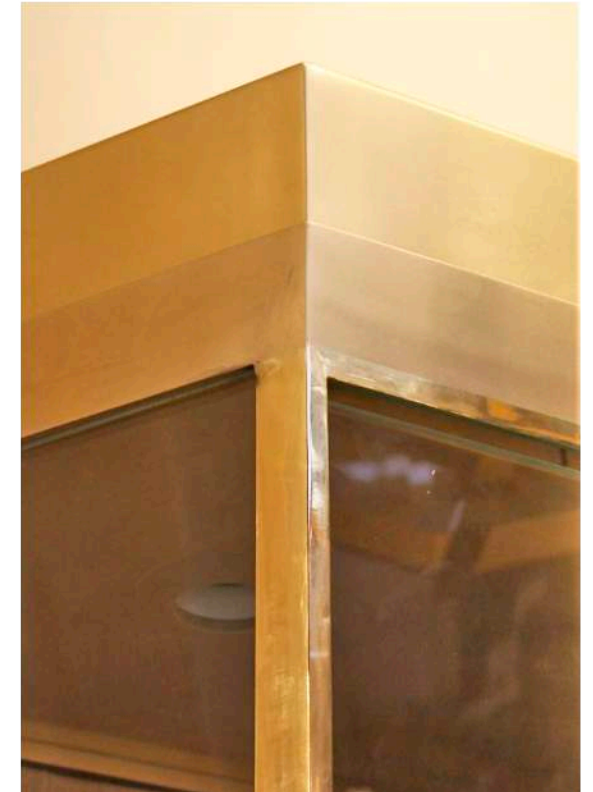
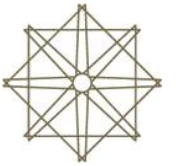

Structure of solid brass with its perfect edges.

Lobby Four Seasons Hotel Madrid

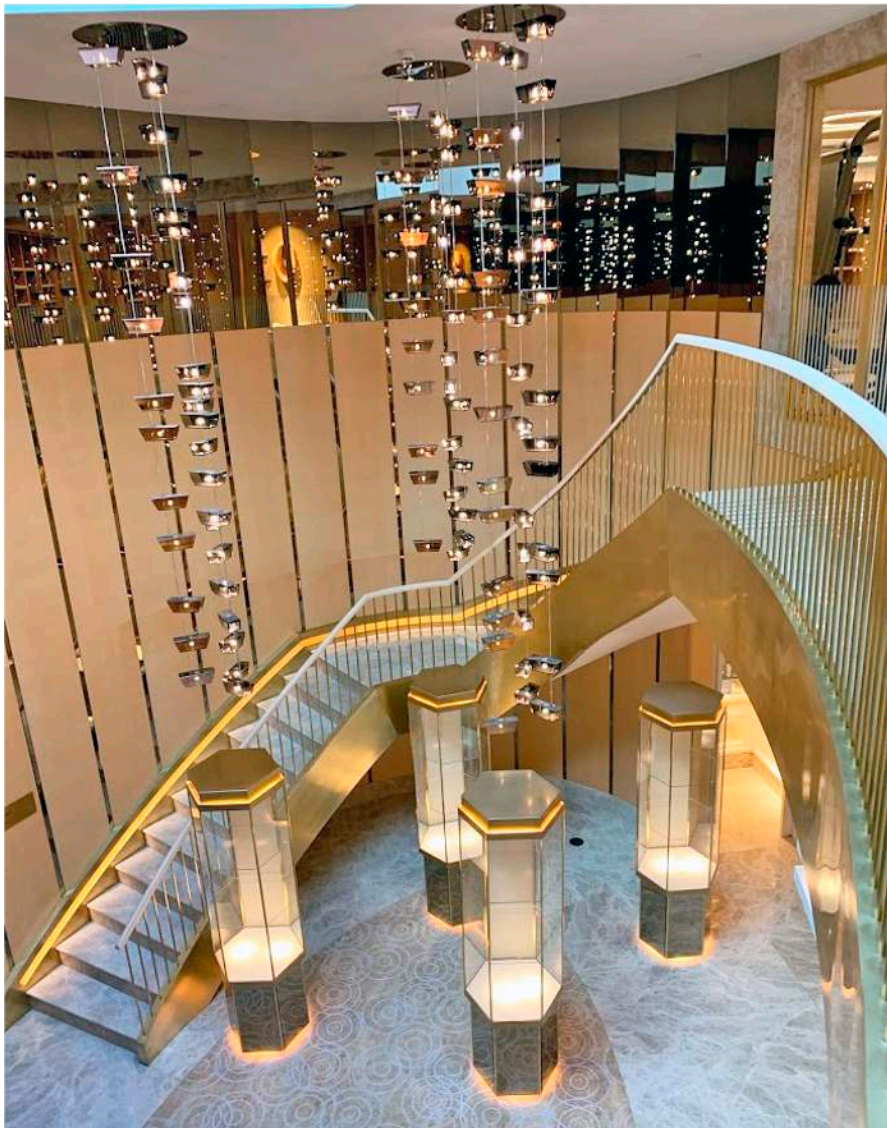

Reception SPA Four Seasons Hotel Madrid

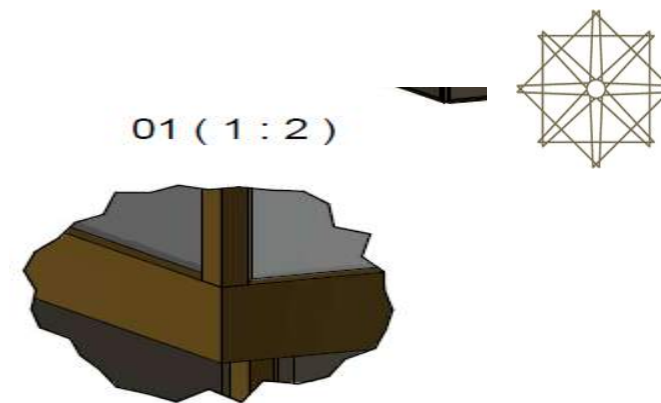

Solid hexagonal profiles where metal and glass fit without using beads or silicones.

- **Unique VITRINAS pieces**
- Material brass
- Measurements 2207 x 670 mm
- Satin and polished finish

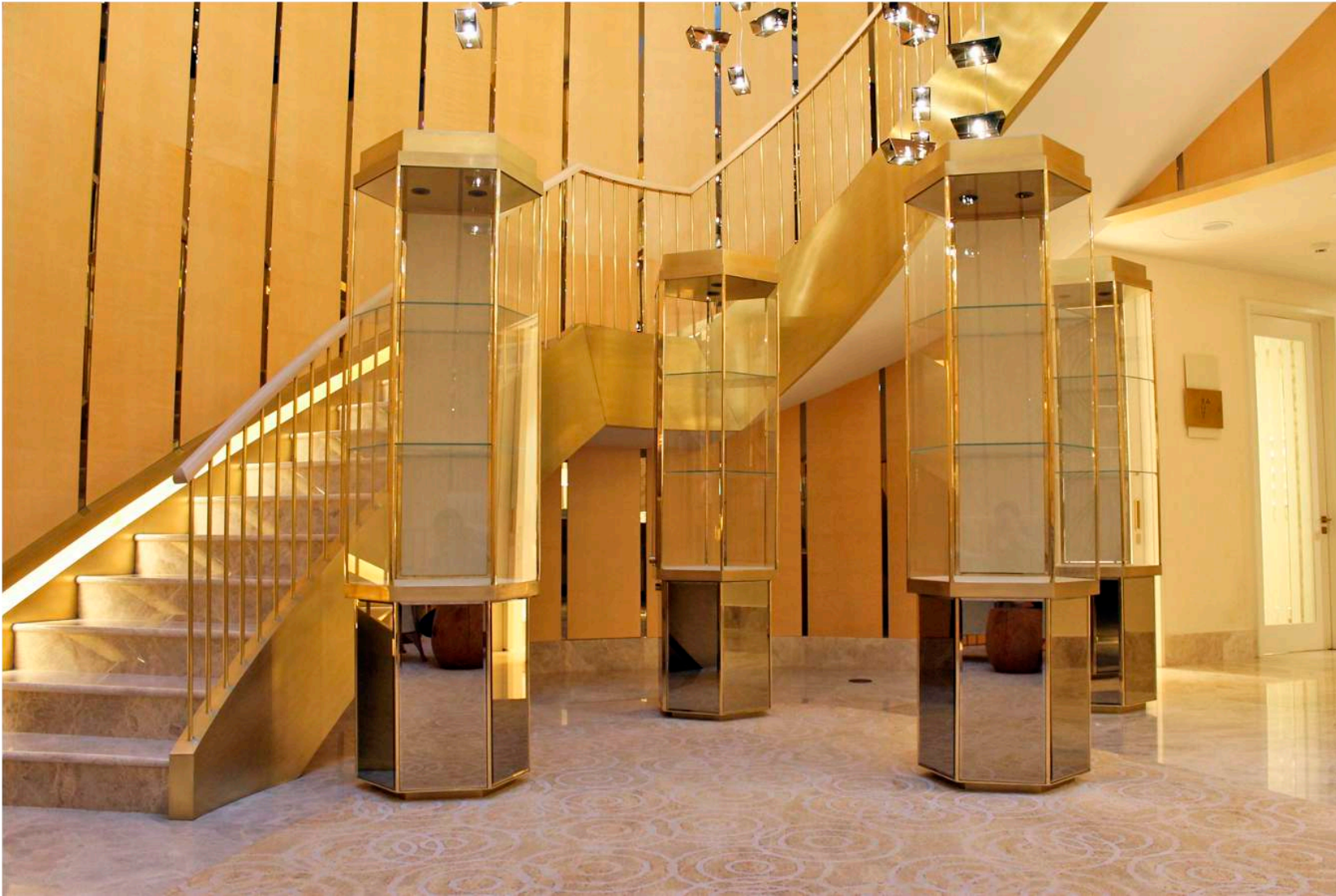
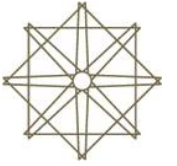

- Set of showcases made of brass, oak and extra clear bronze mirror glass.
- Combination of craftsmanship with the latest CNC technologies.
- Finishes made in organic patinas.

Reception SPA Four Seasons Hotel Madrid



M J M O R E L L

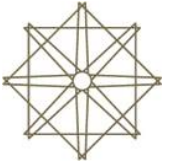
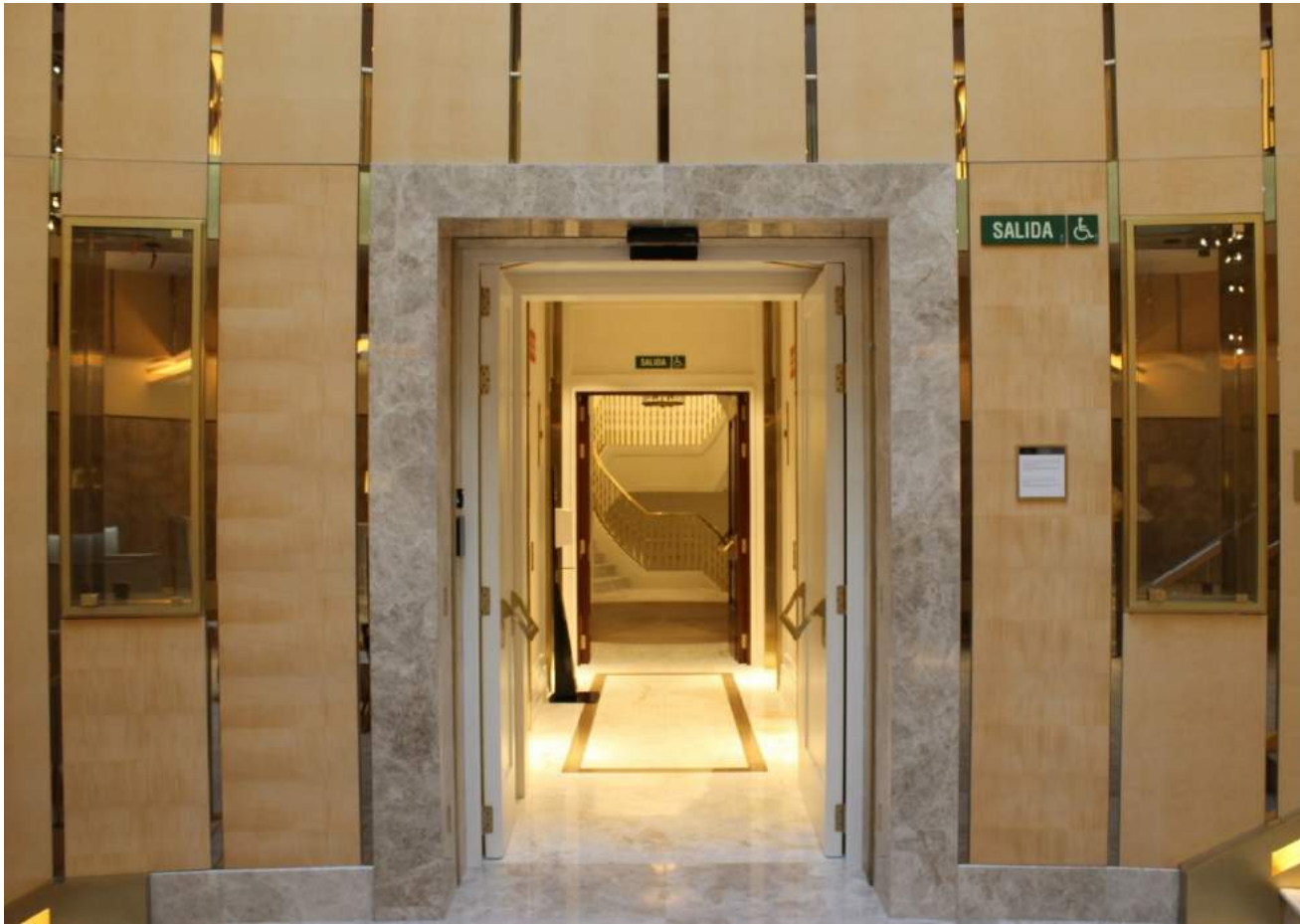

- Unique VITRINAS EMPOTRADAS pieces
- Materials brass, oak, mirrored glass.
- Measurements 2207 x 670 mm
- Satin and polished finish

Reception SPA Four Seasons Hotel Madrid

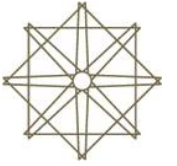

- Unique piece LIVING TABLE.
- Materials brass and natural stone.
- Measurements 3000 x 1200 x 750 h mm
- Satinated brass and lightly polished stone finish.

Royal Suite of Four Seasons Madrid

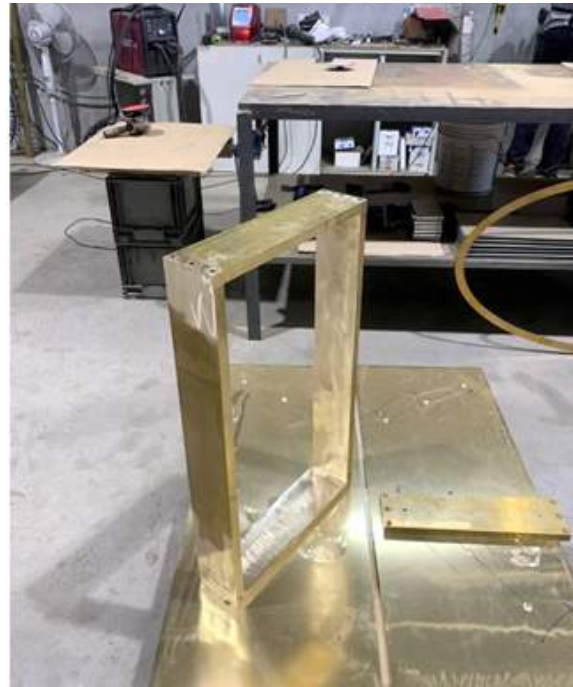
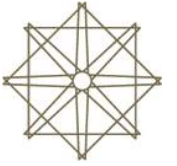

- Manufactured in the workshop by our brass specialists.
- Brass profile table legs.

At the quarry

We are obsessed by the details,
every material is chosen with care.



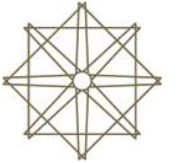

Natural bluing patina made with fire.

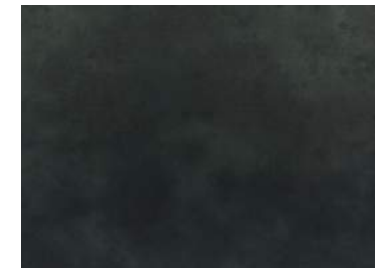

- Unique CONSOLA piece
- Material steel
- Measurements 2400 x 600 x 740h mm
- Bluing finish

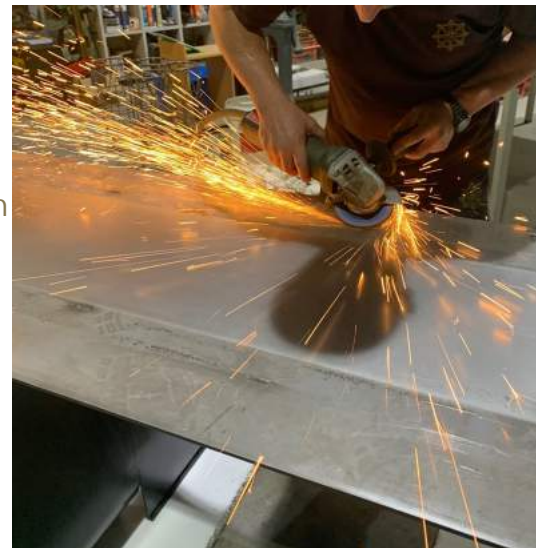

Royal Suite Four Seasons Hotel Madrid



M J M O R E L L

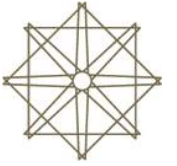

- Unique CONSOLA piece
- Materials wood with shagreen, brass and gilded profiles.
- Measurements 1500 x 560 x 775 h mm
- Natural finish

Royal Suite Four Seasons Hotel Madrid



M J M O R E L L

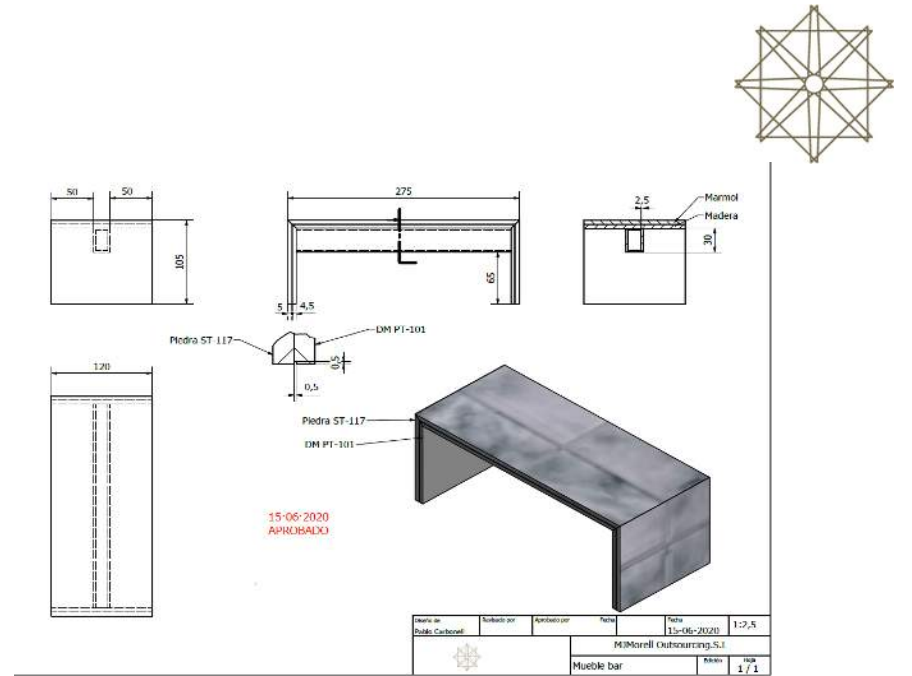

- Unique MINI BAR piece
- Material Calacatta Gold
- Measurements 2750 x 1200 x 105h mm
- Lightly polished finish



Presidential Suite Four Seasons Hotel Madrid



Royal Suite Four Seasons Hotel Madrid



M J M O R E L L

- Unique COFFEE TABLE piece
- Material brass
- Measurements 1800 x 900 x 500h mm
- Organic satin finish

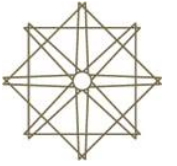

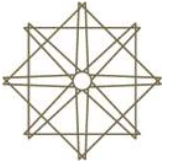

- Unique CONSOLA piece
- Material walnut
- Measurements 2400 x 600 x 740h mm
- High gloss finish



Presidential Suite Four Seasons Hotel Madrid

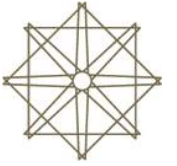

Presidential Suite Four Seasons Hotel Madrid



M J M O R E L L

- Unique ESCRITORIO piece
- Material walnut, oak, brass and leather
- Cherrywood finish

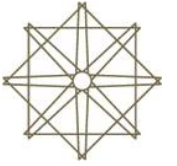

- Unique piece
- Materials brass and acrylic glass
- Measurements 795 x 470 x 855h mm
- Satin finish

Presidential Suite Four Seasons Hotel



M J M O R E L L

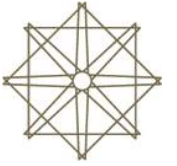

- Unique reception restaurant piece
- Materials brass, oak and natural stone.
- Measurements 950 x 500 x 1100 h mm
- Organic satin finish

Mezzanine Reception Restaurant ISA at Four Seasons Hotel



M J M O R E L L

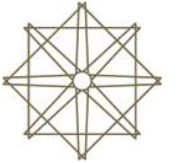

- Unique piece
- Materials stainless steel, oak and leather.
- Measurements 980 x 470 x 835 h mm
- Lacquered and polished finish

Room Red Restaurant Isa at Four Seasons Hotel



M J M O R E L L



Restaurant ISA at Four Seasons Hotel



- Unique TABURETE pieces
- Materials steel and brass
- Measurements 270 x 650 h mm
- Natural patinas and satinated brass finish



In our workshop we develop and manufacture.



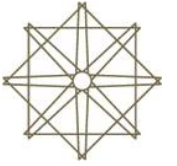

- Unique BANQUETA piece.
- Material solid Wood.
- Measurements 1495 x 450 x 749h mm
- High gloss finish.

Restaurant ISA at Four Seasons Hotel



M J M O R E L L

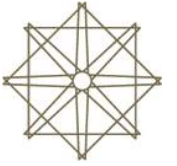

- Unique BUTACA piece.
- Material walnut.
- Measurements 1140 x 700 x 909h mm
- High gloss finish.

Restaurant ISA at Four Seasons Hotel



M J M O R E L L



- Customized unique pieces.
- Material walnut.
- Measurements 1400 x 450 x 2050h mm
- High gloss finish.



- Customized unique pieces.
- Material walnut
- Measurements 850 x 450 x 1000h mm
- High gloss finish

- Woodwork piece for DJ table
- Customized unique pieces.
 - Materials oak and brass.
 - Measurements 850 x 450 x 100h mm
 - Natural finish.

Restaurant Isa at Four Seasons Hotel



M J M O R E L L



EXCELLENCY COSTUMIZED

HANDLES, DOOR HANDLES, TOWEL RACKS ...

At **MJMorell** we have created all the handles, hangers, door handles, recessed handles, towel racks ... fittings for the rooms, common areas and furniture for the Four Seasons Hotel and Private Residences.

To each piece we apply the most suitable manufacturing technique according to design, from the combination of hammered craftsmanship with the latest CNC technologies in the same piece, to lost wax bronze casting, always working with noble materials and giving the finish requested by the client from organic patinas to satinating fire, polished or chrome and nickel electrolytic baths.

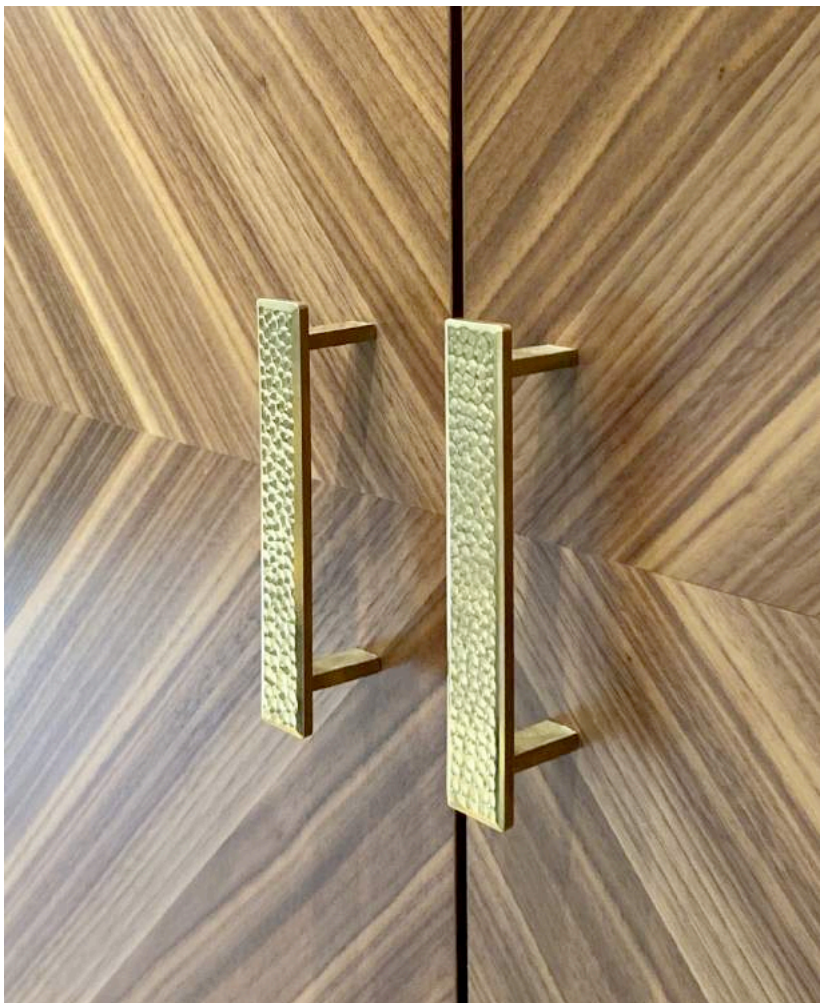

Room Four Seasons Hotel Madrid



M J M O R E L L



Hammered brass profile



Center of CNC machine



- Hammered brass handle.
- Measurements 129 x 21 x 35 mm

In our workshop



M J M O R E L L

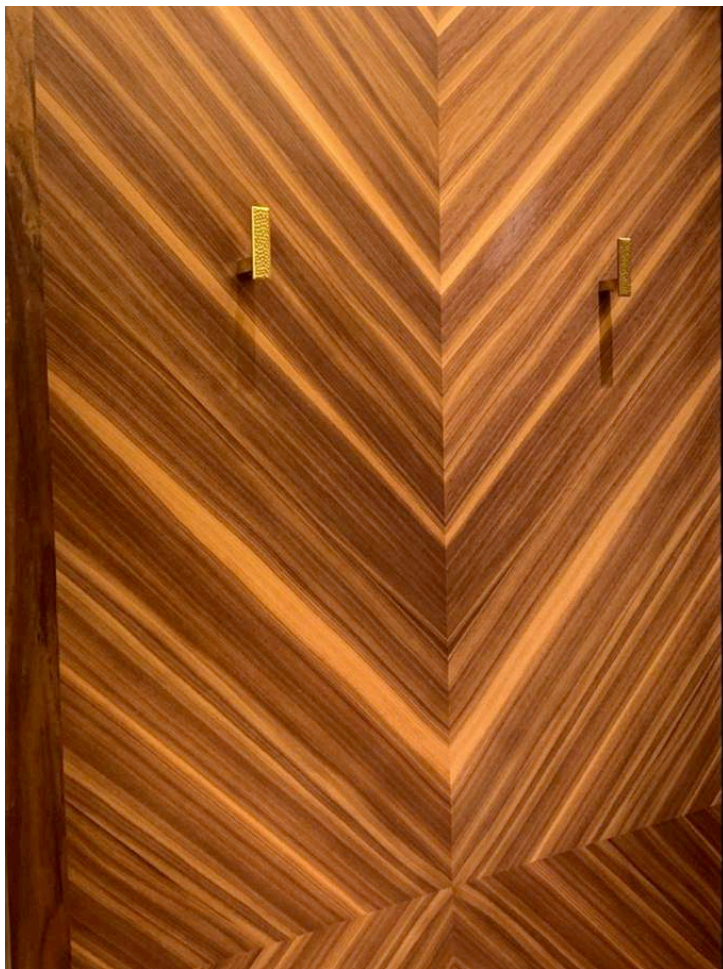

Collection of exclusive handles, hangers, recessed handles and door handles for standard rooms in brass.



- LED protectors on the mini bar shelves.
- Custom made for the different mini bars in brass material and polished organic finish.

Room Four Seasons Hotel Madrid



M J M O R E L L



Parts of the artisanal manufacturing process of our staff every day...



- Hammering
- Brushing
- Welding
- Retouching
- Milling
- Mechanizing
- Bluing
- Waxing

Mechanizing centre

A highly automated machine capable of performing multiple machining operations in a CNC facility with minimal human intervention.



In our workshops we have all kinds of machinery to shape our parts.

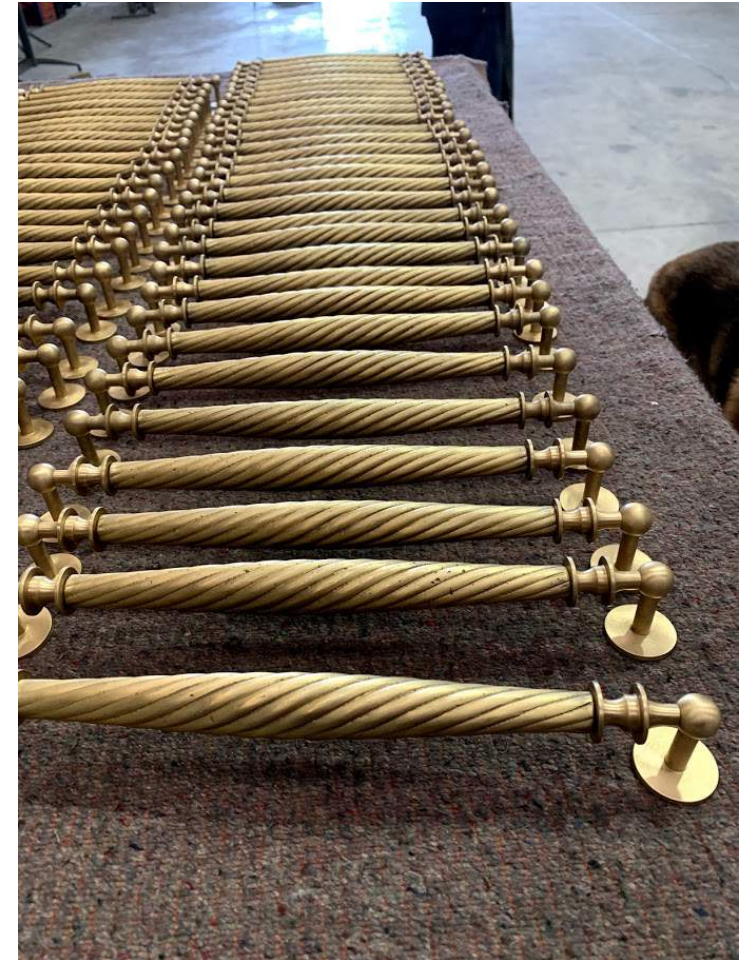
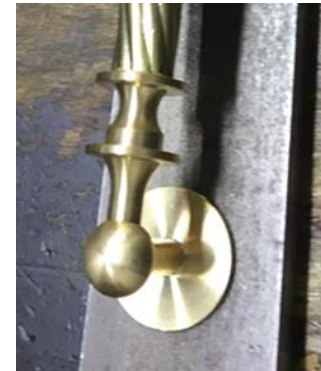

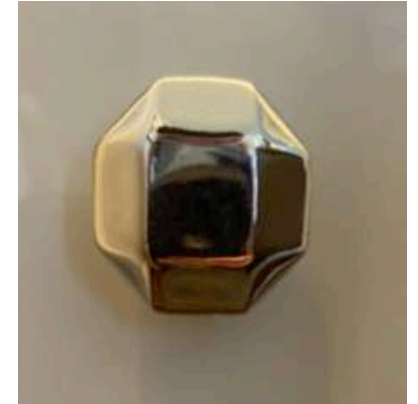

- Handles made of brass with a polished nickel finish.

- Handles made of brass with a polished organic finish.

Handles Royal Suite Four Seasons Hotel Madrid



- Handles for **SPA lockers and numbering** plates are part of the exclusive signage project for the hotel.
- Burnished brass finish



Gym and SPA Four Seasons Hotel Madrid

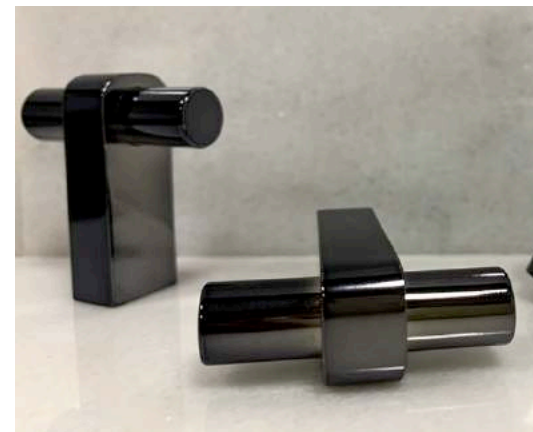

- Brass handle
- Dark chrome finish



- Brass handle
- Dark chrome finish
- Measurements 46 x 12 x 43 mm

Royal Suites Four Seasons Hotel Madrid

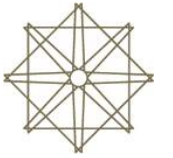

Collection of handles, door handles and towel racks for Private Residences in polished chrome-plated brass.

Private Residences Four Seasons Hotel Madrid

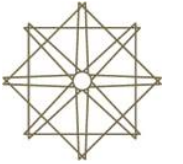

EXCELLENCY COSTUMIZED

At MJMorell we are passionate about building long-term relationships with our clients, with whom we create exclusivity, luxury, mutual value and share knowledge.

We provide the most adequate human and technical resources at all times. All this by providing comprehensive project management advice, standardizing processes and offering a complete solution for total quality assurance to our clients.



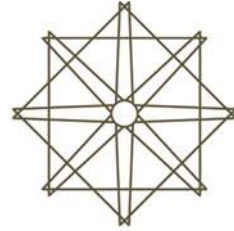
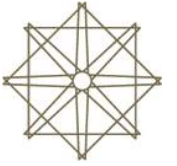

M J M O R E L L

EXCELLENCY COSTUMIZED



M J M O R E L L



www.mjmorell.com



mariajose@mjmorell.com



[@mjmorell_outsourcing](https://www.instagram.com/mjmorell_outsourcing)